



MANUALLY OPERATED PATIO AWNING



Before operating the awning, carefully review the Owner's Manual. The manual contains important safety information, detailed operating instructions, common maintenance procedures and other useful information.



Table of Contents

Introduction	2
Warnings and Cautions	2
Operation	3
Opening the Awning	3
Adjusting the Pitch	4
Rain Release Setting	4
Setting the Arms in the Carport Position	5
Closing the Awning	6
Awning Care	7
Fabric Care	7
Mildew	7
Pooling	7
Leaking	7
Arm Care	7
Carefree Major Product Limited Warranty	8

INTRODUCTION

From its beginning in the early 70's, Carefree of Colorado has emerged as the premier manufacturer of quality awnings and accessories for Recreational Vehicles (RVs). Our full line of products can provide the accessories that match your life style; no matter what type of RV you own.

The Carefree line of traditional rollup awnings provides the RV owner with choices of multiple fabrics and options while having some of the strongest and long lasting hardware in the industry.

The adjustable arms allow the user to adjust the pitch of the awning and can be placed in the carport position when desired. Additional refinements include a remote lock, storage travel locks and canopy clamps to help tension the fabric. Additional fabrics with Weatherguard or Alumaguard are available.

WARNINGS AND CAUTIONS





This is the safety alert symbol. It is used to alert individuals to potential personal injury hazards. Obey all safety messages that follow this symbol to avoid possible personal injury or death.

 **WARNING** This product can expose you to chemicals including Diisodecyl phthalate (DIDP), Vinyl Chloride and Formaldehyde, which are known to the state of California to cause cancer or birth defects or other reproductive harm. For more information visit www.P65warnings.ca.gov



 **WARNING** Risk of fire. Keep all sources of heat and flame away from the awning canopy. Fabric is NOT fireproof.

 **NOTICE** Awnings are designed to provide shade and protection from the sun. The effects of wind and rain on an awning are unpredictable and can cause severe damage to the awning and/or the vehicle. If wind or extended periods of rain are expected, roll up the awning.

 **NOTICE** It is recommended that if leaving the RV unattended for a length of time, retract the awning to avoid unexpected weather conditions.

 **NOTICE** If installed, LED lighting must be turned off when the awning is in the rolled up position. This is to prevent possible damage to the LEDs and/or canopy.

Additional Cautions and Notices are included in the text for the proper operation of the awning.

OPERATION

Operation of the Carefree Manual Patio Awning is simple and straight forward. Please observe the safety notes and cautions for best results. Some options described may not be available for all models.

OPENING THE AWNING

CAUTION Always use the pull strap to extend or retract the awning. Do not open or close the awning by holding onto the arms. Serious injury could occur if hands or fingers are pinched between the arm and brace.

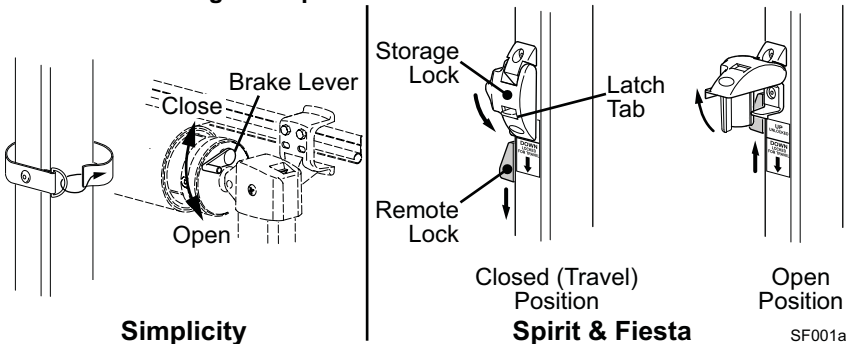

1. Release the arm travel lock:
 - *For Simplicity:* Release the velcro and pull the ARM STRAP from the ring and unwrap from around the arms.
 - *For Spirit and Fiesta:* Press up the latch tab then lift the ARM TRAVEL LOCK up. Repeat for the second arm.
2. Unlock the roll bar:
 - *For Simplicity:* Using the pull wand, hook and pull the BRAKE LEVER down to the open position. This is located on the right end of the roll bar.
 - *For Spirit and Fiesta:* Press the REMOTE LOCK up until it stops. This is located on the right arm, behind the arm travel lock.
3. Loosen the black lock knob on the upper brace of both arms.
4. Using the PULL STRAP, pull the awning out.
5. Push the braces up to the top of the arm. The brace sliders have a small spring catch that latches into the roll bar end plug when the brace is fully lifted to the top of the arm.

CAUTION Always use the support braces to hold the awning out in the extended position. Failure to use the support braces may result in the awning inadvertently rolling back up to the travel position possibly causing injury or damage to the awning or the RV. Personal injury or damage may occur that are not be covered by warranty.

6. While pressing outward on the roll bar to tension the fabric, tighten the black lock knob on the brace. Repeat for the other side.

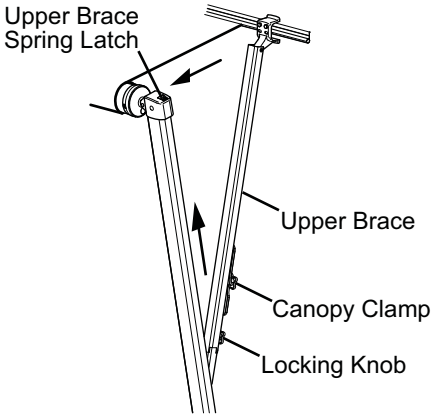

Opening the Awning

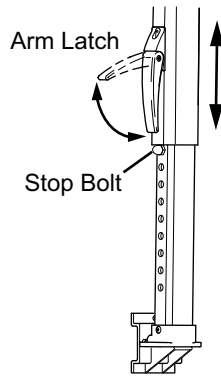

Adjusting the Pitch

SF009a

7. For Awnings w/ Canopy Clamps:
 - Loosen the clamp knob until the shaft portion clears the brace.
 - Swivel the clamp toward the canopy and set the clamp jaws around the fabric.
 - Tighten the knob. Use caution to not over tighten the knobs; this will actually cause the clamp to loosen and release the fabric.

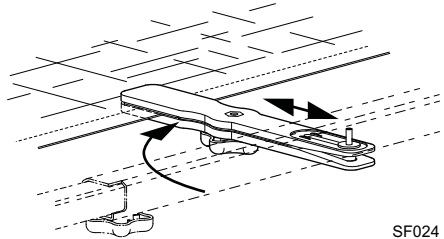

ADJUSTING THE PITCH

1. Open the arm lever.
2. Slide the upper arm channel out until the desired pitch is achieved.
3. Close the arm lever. It may be necessary to move the arm up and down slightly for the lock pin to snap into a position hole.
4. Repeat for other side.

RAIN RELEASE SETTING

The effects of wind and rain on an awning are unpredictable. Severe damage to the awning and/or the vehicle may result. IF WIND OR EXTENDED PERIODS OF RAIN ARE EXPECTED, ROLL UP THE AWNING AND SECURE FOR TRAVEL.

If the awning is extended during rain, position one arm at minimum pitch and the other arm at maximum pitch. This will provide slope to allow the water to run off and prevent pooling.

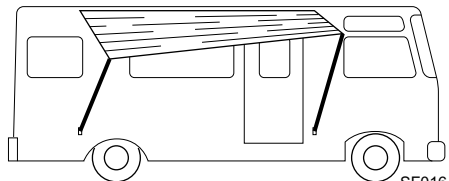

SETTING THE ARMS IN THE CARPORT POSITION

When it is desirable to have an open walkway from the side of the awning, the arms can be set in the carport position. In this position, the arms are set perpendicular to the ground surface.

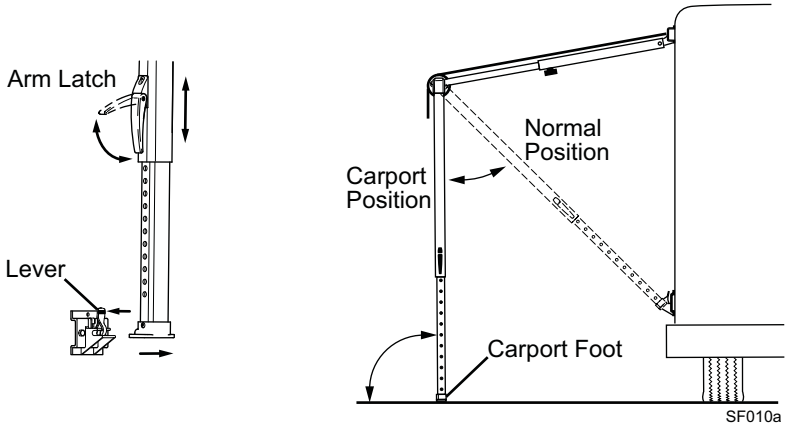

1. Open the awning.
2. After the braces have been locked into position and the black knobs are tightened, push the brake lever to the close position.
3. While supporting the arm and roll bar, release the carport foot from the bottom support bracket. The latch is spring loaded. While holding the latch open, slide the arm from the bracket.
4. Rotate and set the arm perpendicular to the ground.
5. Repeat steps 2 and 3 for the other arm.
6. Set the brake lever to the open position.
7. To secure the arms, stake the carport feet to the ground. Stakes are not included with awning.

CLOSING THE AWNING



CAUTION

Once the awning roller lock is placed in the Roll In or Close position the awning is under full spring tension. If not firmly held, the awning will abruptly roll up to the stored position possibly causing personal injury or damage to both the awning and the RV.

1. Disconnect, remove and/or store any optional equipment that is used (i.e. rafters, hangers etc.) Follow the storage directions furnished with the particular option(s).
2. If the awning has been placed in the carport configuration:
 - Remove the stakes holding the carport foot.
 - Set the brake lever to the close position.
 - Swivel the arm back and lock the carport feet into the bottom mounting bracket.
 - Set the brake lever to the open position.
 - Repeat for the second arm.
3. Return the arm length to the storage length:
 - Open the arm lever and slide the upper arm channel down to the stop bolt.
 - Close the arm lever. It may be necessary to move the arm up and down slightly for the lock pin to snap into the position hole.
 - Repeat for the second arm.
4. Loosen the black lock knob for the brace.
5. Disengage the spring latch for the brace (located on the top of the roll bar end plug) and slide the brace down the arm. It may be necessary to press out on the roll bar to ease the tension. Repeat for the second arm.
6. Firmly grasp the pull strap and set the brake lever to "CLOSE". *For all models:* The brake lever is accessible by hand when the awning is extended.
Tip: The pull strap can slide along the roll bar. Move the strap toward to the right end of the roll bar to easily hold the strap and operate the brake lever.
 - *For Simplicity:* Push the BRAKE LEVER up to the CLOSE position. This is located on the right end of the roll bar.
 - *For Spirit and Fiesta:* Press the BRAKE LEVER down until it stops. This is located on the right end of the roll bar, the remote lock is attached to the lever.
7. Allow the awning to roll up slowly until it is completely closed.
8. Secure the arms:
 - *For Simplicity:* Thread the strap through the ring and attach the velcro securely. Repeat for the second arm.
 - *For Spirit and Fiesta:* Press the ARM TRAVEL LOCK down until the latch tab clicks. Repeat for the second arm.
9. Tighten the black lock knob on the braces.

The awning is now ready for travel and storage.

AWNING CARE

Maintaining a Carefree Awning is easy. Just follow these basic steps:

- Periodically check that the fasteners are tight. Tighten if necessary.
- Keep the awning fabric and arms clean.

FABRIC CARE

NOTICE Do not use oil based cleaners or any caustic, granulated, or abrasive type cleaners on your Carefree product.

1. One of the best ways to keep the fabric looking good and to delay the need for deep or vigorous cleanings is to hose fabrics off on a monthly basis with clear water. This practice will help prevent dirt from becoming deeply imbedded in the fabric. In most environments, a thorough cleaning will be needed every two to three years.
2. For a thorough cleaning, the fabric can be cleaned while still on the awning frame.
 - For Vinyl Fabric – Use a soft brush and warm water with soap.
 - For Acrylic Fabric – Use a stiff brush and warm water with soap.
3. When cleaning the fabric, it is important to observe the following:
 - Always use a natural soap, never detergent.
 - Water should be cold to lukewarm, never more than 100°F.
 - Air-dry only. Never apply heat to the fabric.
 - Always allow the fabric to dry thoroughly before rolling up the awning.

MILDEW

Mildew is a fungus growth that looks like dirt. Vinyl coated polyester fabrics are mildew resistant because of a chemical biocide in the vinyl coating. Under ordinary conditions, mildew will not appear. However, in areas where high temperature and humidity are common, mildew can be a problem and required the material to be washed more frequently. Thoroughly rinse the fabric with clean water and allow to air dry completely before rolling up the awning.

POOLING

When water collects on the top of the fabric, this is known as "pooling". This can occur during inclement weather or if a running air conditioner discharges over the awning. The water is dumped when the awning is retracted. It is recommended that if water accumulates on the top; retract the awning in steps (8"-12") to dump the water. This will help prevent the fabric from stretching or distorting.

LEAKING

On vinyl canopies, side hems and poly cords are stitched in with a sewing machine. On occasion, this stitching may allow water to seep or leak through the stitches. This is normal and not a defect covered by warranty. Treat the seams with a seam sealer.

ARM CARE

The best method of keeping the arms and braces operating smoothly is to clean them. Dirt and debris can cause the channels not to slide easily. Periodically wash out the channels with running water (i.e. a hose) to keep them clean. If the channels still do not slide easily, lightly spray the inside of the channels with a dry silicone lubricant, after the arms have been cleaned and dried thoroughly.

Locking knobs should be periodically loosened and removed then sprayed with a dry lubricant to prevent binding and locking.

CAREFREE MAJOR PRODUCT LIMITED WARRANTY

Carefree of Colorado (hereafter referred to as Carefree) warrants to the first retail Purchaser that the Carefree Product is free of defects in material and workmanship within the terms and conditions as set forth in the warranty statement available online at www.carefreeofcolorado.com. Carefree's obligation under this warranty is limited to the repair or replacement, at Carefree's option, of any defective component with new or factory refurbished components.

OWNER MUST RETAIN THE ORIGINAL PROOF OF PURCHASE AND/OR HAVE THE PRODUCT WARRANTY REGISTRATION ON FILE AT CAREFREE FOR WARRANTY CLAIMS.

THIS WARRANTY IS NOT TRANSFERABLE.

Visit www.carefreeofcolorado.com for

- Warranty Duration;
- Warranty Coverage and Exclusions;
- Warranty Terms of Coverage; and,
- Warranty Claim Procedures

Register your Carefree products on-line at www.carefreeofcolorado.com

IMPORTANT NOTICE: It is strongly recommended that adjustments and repairs not described in this book be performed by trained technicians at your Authorized Carefree Dealer. Work performed by non-authorized persons or businesses may void warranty.

